

System SK6 Radii profiles



The new patented master key
system profiles

ZIKON
ASSA ABLOY

IKON – The locking system specialist since 1926!

Experience a safer
and more open world

IKON mechanical locking system:

The new radii profiles are a worthwhile investment in your safety and security

Small marvels of technology: the durable, mechanical IKON locking systems.

IKON mechanical locking systems have been proving their worth for decades in countless buildings - on company premises, in institutions or in residential buildings. Hardly any other manufacturer in Germany has more locking systems on the market or is able to install larger and more complex systems than IKON. IKON mechanical lockings systems impress due to their reliable technology, perfect precision, optimum quality and proven long life cycle. This also applies to the radii profiles in the special class SK6:

The newly developed and patented IKON **radii profiles** are based on a high-quality and stable key blank made of nickel silver with six active spring-mounted pin tumblers. The profile match of the key is arranged parallel to the back of the key. The profile features are designed as radii. The specific arrangement of radii on the variable and fixed profile features on the outside of the key makes it significantly more difficult to read and copy keys. The radii profiles are characterised by a high level of protection against break-ins, scanning and lock picking compared to conventional key profiles.

Advantages of radii profiles at a glance:

- High-quality locking systems with long-term patents
- Profiles available for all applications and requirements – from basic requirements to highly complex master key systems
- Optional increased copy protection with side profile control pin already possible in the basic version
- Upgrade from Radii profile to radii profile Extra possible at a later date
- Upgrade with CLIQ technology for Radii profile, Radii profile plus and Radii profile Extra possible
- active spring-mounted pin tumblers in accordance with DIN EN 1303 or DIN 18252 = security against break-ins, scanning and lock picking
- DIN EN 1303, lock security class 6
- DIN EN 1303, intrusion resistance class 0, optionally with drilling protection class B/D and pulling protection
- Optional DIN 18252:2006-certified, class 82*, with drilling protection and optional cylinder protection
- High-quality, stable nickel silver key with 13 mm key neck and ergonomic, square key head
- Increased drilling protection as standard thanks to the use of a hardened steel pin in the cylinder housing and the first pair of steel pins
- High pulling protection as standard thanks to the use of a clawed nickel silver cam
- Protected key profile with security card
- Keys available with integrated transponder
- Optionally available with colour pins
- Very wide range of cylinder variants and types
- Fast and easy ordering
- Simple master key system management
- Reliable technology, perfect precision, high quality and proven long life cycle.

* Intrusion resistance classes 1 and 2 or A and B require no pulling protection if the cylinder is used with drilling protection in combination with ES2 ZA class security fitting with pulling protection.



Protected key profile with security card

The high-quality, patented radii profile: The new profile of the SK6 system



The "radii patent" makes it more difficult to read and copy keys.

The so-called "radii patent" describes the arrangement of radii on the variable and fixed profile features on the outside of the key as well as on the variable profile features in the key base. This makes it more difficult to read and copy keys.

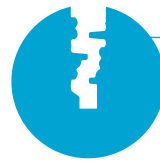

Radii patent



+CLIQ is the mechatronic solution for upgrading IKON mechanical locking systems.

The option for higher demands: Upgrade with +CLIQ for Radii profile, Radii profile plus and Radii profile Extra

Situations may arise where your mechanical master key system requires reinforcement from mechatronic components. Such situations could include a higher security level being required for sensitive areas in your building or the need for greater flexibility for access authorisations. The solution lies in IKON +CLIQ technology. This sys-

tem integrates chip technology into mechanical locking cylinders and their corresponding keys.

As a result, access or locking is controlled on two levels: by mechanical locking and through electronic identity.

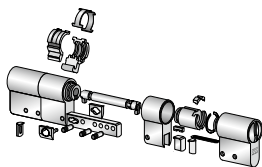











Also available as a modular system (Modular) GBK=J

A wide range of colour pins is available as an option

We offer an optional wide range of colour pins for our keys with square-cut key heads. These colour pins will help you to identify the keys for example their locking authorisations. That makes it much easier to manage keys.



 RD=6SW Black	 RD=6GR Grey	 RD=6GN Green	 RD=6RT Red	 RD=6BR Brown
 RD=6BL Blue	 RD=6WS White	 RD=6GE Yellow	 RD=6VI Purple	 RD=6OR Orange

System SK6

Radii profile and Radii profile Plus

The new patented SK6 radii profiles in the 1st and 2nd security level is characterised by six active spring-mounted pin tumblers. In the 2nd security level, a profile control pin with key catch function

is optionally available, which also provides greater technical key copy protection. This profile control pin can also only be used in selected locking cylinders, e.g. on security-relevant external doors.

Radii profile:

6 tumblers | Suitable for system types GM, M, ComMC, C, CM

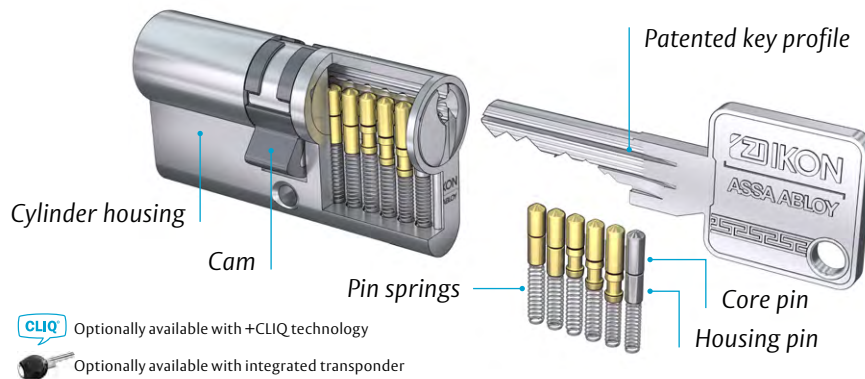

Radii profile Plus:

6 tumblers + profile control pin | Suitable for system types GM, M, ComMC, C, CM

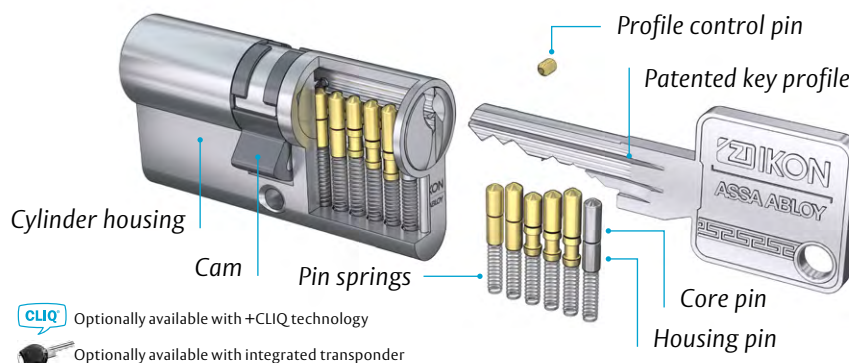

Increased key copy protection thanks to the **profile control pin**: The deviations of an illegally produced key copy lead to this key being "caught" and a blockage in the cylinder.

Special features

- 6 active spring-mounted pin tumblers in accordance with DIN EN 1303 or DIN 18252 = security against break-ins, scanning and lock picking.
- Suitable for system types GM, M, ComMC, C, CM
- Increased protection against lock picking and bumping
- Optionally available with increased technical key copy protection (KCP=KT1) by using the profile control pin with key catch function
- Upgrade to the SK6 Radii profile Extra possible in the event of key loss or locking system extension

System SK6

Radii profile Extra

The patented Radii profile Extra features up to eleven active spring-mounted pin tumblers. The key of the Radii profile Extra has an additional encryption, which is scanned by up to five active spring-mounted ball pins in the locking cylinder.

This type of control on the side of the key profile ensures there are more options for combining and organising systems and also provides even greater protection against lock picking and key copying.

Up to five additional active spring-mounted ball pins ensure extra security.

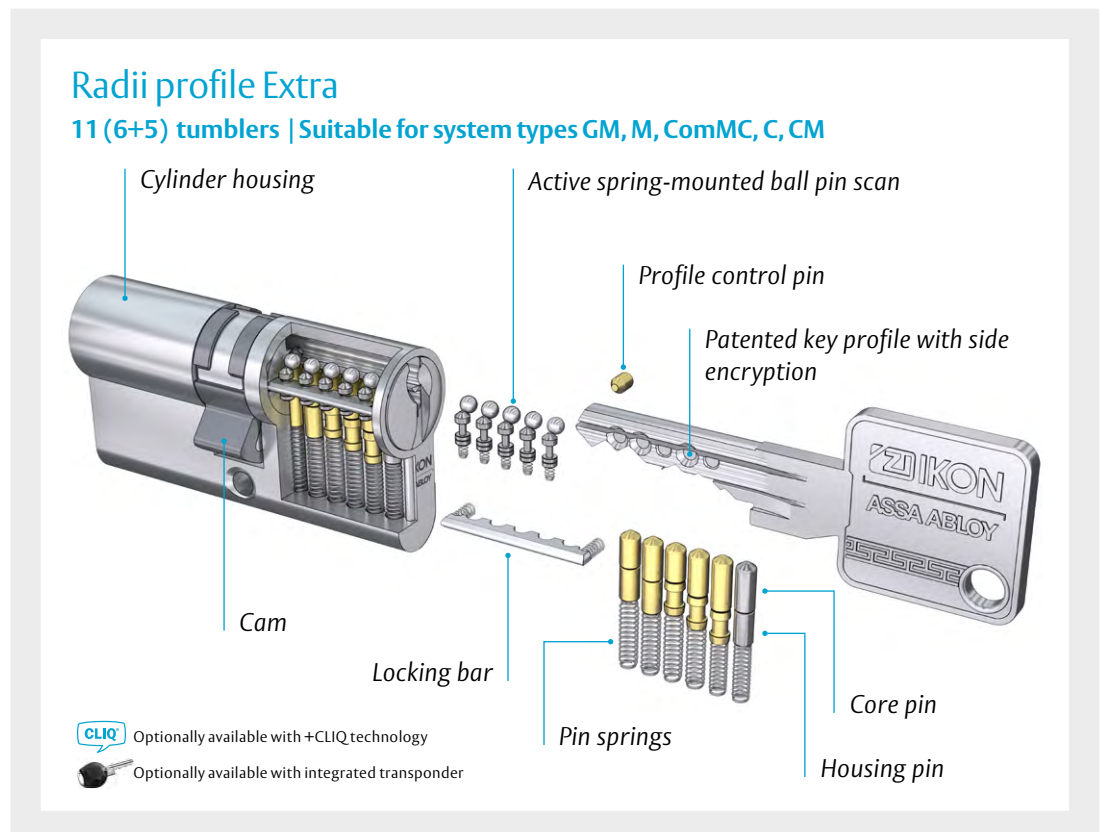

Special features

- 11 (6+5) active spring-mounted pin tumblers in accordance with DIN EN 1303 or DIN 18252 = security against break-ins, scanning and lock picking
- Up to 5 additional active spring-mounted ball pins and corresponding encryption on the key in accordance with DIN EN 1303 or DIN 18252
- Suitable for system types GM, M, ComMC, C, CM
- Increased protection against picking and bumping due to special profile design and pin combination
- Available as standard with increased technical key copy protection (KCP=KT1) by using the profile control pin with key catch function
- Optional VdS approval, class B, with drilling protection, optional cylinder protection (BZ)

System SK6

Radii profile Blocking wave

The patented Radii profile Blocking wave is characterised by ten active spring-mounted pin tumblers. An additional encryption, the locking wave, is cut in to the long sides of the key. This encryption is read by special spring-borne tumblers in the locking cylinder. If a key with missing or incorrect encryption is used, the locking action

will be blocked. The additional undercut in the key profile gives the key a more complex shape and consequently increases copying protection. The locking wave profile meets requirements for mechanical protection against key copying and against lock picking to a very large extent.

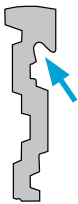

The additional undercut in the key profile makes the key more complex and consequently increases copying protection.

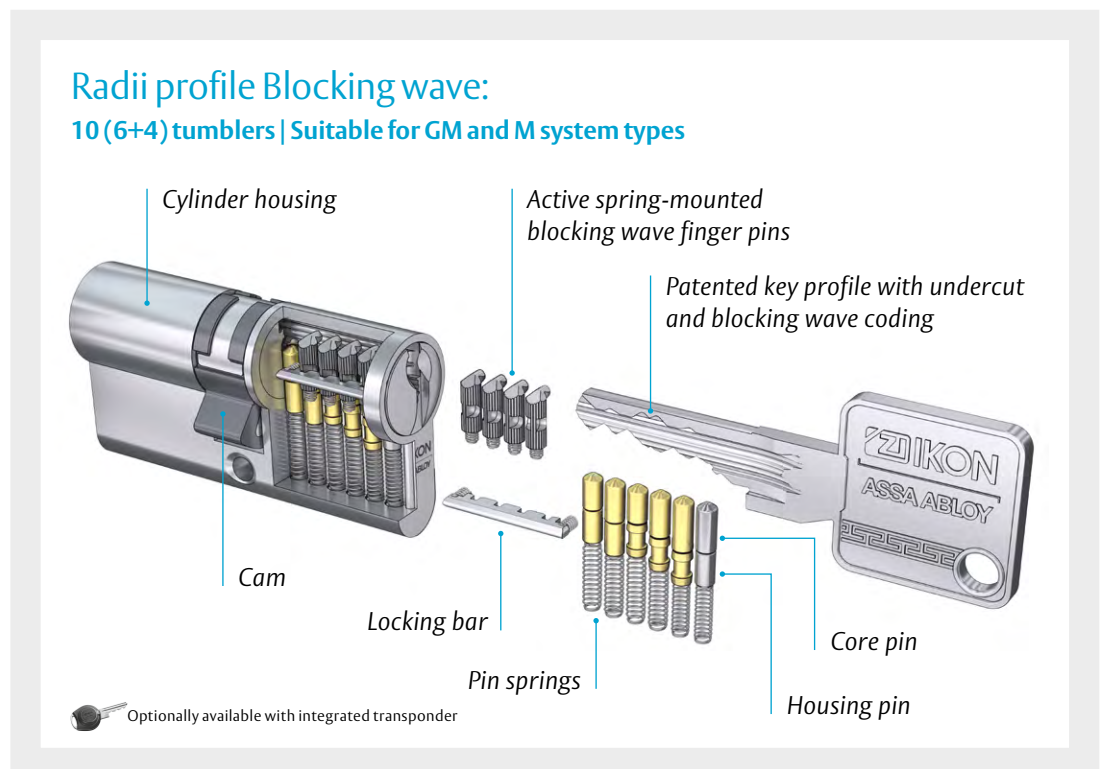

Special features

- 10 (6+4) spring-mounted, actively operating tumblers according to DIN EN 1303 or DIN 18252 = protection against lock picking
- Paracentric key profiles with additional blocking wave encryption and undercut = protection against lock picking
- DIN 18252, class 80
- Optimum protection against lock picking and bumping thanks to additional blocking wave, pin combination and supplementary blocking wave encryption
- Optional VdS approval, class B, with drilling protection, optional cylinder protection (BZ)

IKON locking cylinders

Quality characteristics



IKON locking cylinders offer high quality and security.

Surface finishes

With IKON locking cylinders, your master key system can be perfectly matched to the particular style of your doors, depending on the system. In addition to the standard nickel-plated satin finish, there are other surface finishes available for profile cylinders, furniture cylinders and external cylinders.

Burglary prevention:

Locking cylinders must be protected against breaking, drilling, pulling and other forceful attacks. Locking cylinders with drilling protection, core extraction protection and locking cylinder extraction protection offer a high level of security against these methods of attack.

Drilling and extraction protection

Standard drilling protection: the first pair of pins is made of steel and there is a hardened steel pin in the cylinder body (AB=0 at no extra charge).

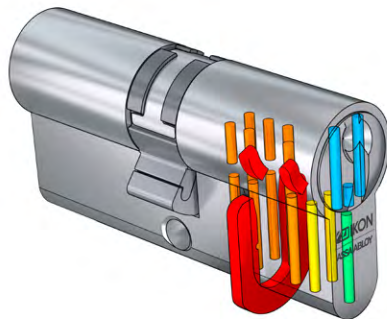

- Cylinder with standard drilling protection
AB=0 green
- ■ Cylinder with reinforced drilling protection
AB=1 green + blue
- ■ ■ Cylinder with strong drilling protection
AB=2 green + blue + yellow
- ■ ■ ■ Cylinder with high drilling protection
AB=3 green + blue + yellow + orange
- ■ ■ ■ ■ Cylinder with high drilling protection and core extraction protection
AB=KS green + blue + yellow + orange + red

Note

Intrusion resistance classes 1 and 2 or A and B require no pulling protection if the cylinder is used with drilling protection in combination with ES2 ZA class security fitting with pulling protection.

Unlocking protection:

Every attempt to overcome our locking cylinders with opening tools is countered by a series of technical precautions, such as ball pins, **paracentric key profiles** and additional locking elements. IKON locking cylinders offer a high level of protection against lock picking.

Copy protection with the key catch function

Only genuine IKON keys may be used, as the KCP=KT1 cylinders are fitted with a key catch function, which traps unauthorised key copies and blocks them in a specific position.

Protection against unauthorised opening

The large number of possible locking configurations and low manufacturing tolerances ensure the risk of an IKON locking cylinder being unlocked with a different key is kept to an absolute minimum.

Functional security:

IKON locking cylinder technology is designed for a long life span. This is based on many technical details. The tight tolerances of locking cylinders and keys are a high security factor. It is important to maintain these tolerances over a long life span.

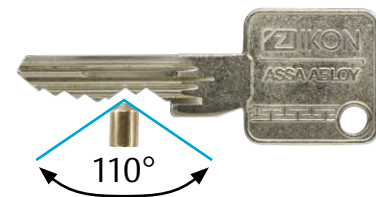

For example: The 110° flank support selected by us ensures precise scanning and function even after a long time in operation.

Key security:



The security value of master key systems systems and series locks includes measures to prevent unauthorised procurement of key copies. Replacement keys for master key systems and series locks are only supplied via specialist retailers upon presentation of the issued security card. IKON keys are also difficult to copy due to their complicated geometries.

The ASSA ABLOY Group is the global leader in access solutions. Every day we help people feel safe, secure and experience a more open world.

ASSA ABLOY
Opening Solutions

ASSA ABLOY Sicherheitstechnik GmbH

Bildstockstrasse 20
72458 Albstadt
GERMANY
Tel. +49 7431 123-0
albstadt@assaabloy.com

Attilastrasse 61 – 67
12105 Berlin
GERMANY
Tel. +49 30 8106-0
berlin@assaabloy.com

www.assaabloy.com/de

ASSA ABLOY Austria GmbH

Hütteldorfer Strasse 216 c
1140 Vienna
AUSTRIA
Tel: +43 (0) 1 212 51 11
wien@assaabloy.com

www.assaabloy.com/at